



Ocean Master

350/390/420/460/500/540/590

Deluxe

350/390/420/460/500/540/590/640

Owner's Manual

Before operating your boat, please read this manual carefully

PLEASE KEEP THIS MANUAL IN A SECURE PLACE, AND HAND IT OVER TO THE NEW OWNER WHEN YOU SELL THE BOAT.

Content

General Introduction	3
Safety alerts	4
Safe Boating Recommendations	4
Pre-operation check list	5
Specifications: Ocean Master	6
General Arrangement	6
Specifications: Ocean Master	7
General Arrangement	7
Specifications: Deluxe	8
General Arrangement	8
Specifications: Deluxe	9
General Arrangement	9
Recommended Seating Arrangement (Ocean Master).....	11
Recommended Seating Arrangement (Deluxe)	12
Builder' Plate:	13
Fuel System	13
Information connected with the risk of flooding and stability	14
Information connected with the risk of fire or explosion	17
Electrical Systems	19
Transporting.....	20
Engine Start.....	20
Operation.....	21
Man-overboard prevention and recovery	24
Maintenance.....	25
Warranty	28
Service assistance	29

To ensure that you gain maximum satisfaction from your Highfield boat, please read this Owner's Manual carefully. It contains all the safety and operation instructions that you need to get the most out of your new Highfield.

General Introduction

This manual has been compiled to help you to operate your boat with safety and pleasure. It contains details of the boat; the equipment supplied or fitted; its systems and information on their operation. Please read it carefully, and familiarize yourself with the boat before using it.

This owner's manual is not a course on boating safety or seamanship. If this is your first boat, or if you are changing to a type of boat you are not familiar with, for your own comfort and safety, please ensure that you obtain handling and operating experience before "assuming command" of the boat. Your dealer or national sailing federation or yacht club will be pleased to advise you of local sea schools, or competent instructors.

Ensure that the anticipated wind and sea conditions will correspond to the design category of your boat, and that you and your crew are able to handle the boat in these conditions.

Even when your boat is categorized for them, the sea and wind conditions corresponding to the design categories A, B and C range from severe storm conditions for category A, to strong conditions for the top of category C, open to the hazards of a freak wave or gust. These are therefore dangerous conditions, where only a competent, fit and trained crew using a well maintained boat can satisfactorily operate.

This owner's manual is not a detailed maintenance or trouble-shooting guide. In the case of difficulty, refer to the boat builder or his representative. If a maintenance manual is provided, use it for the boat's maintenance.

Always use trained and competent people for maintenance, fixing or modifications. Modifications that may affect the safety characteristics of the boat shall be assessed, executed and documented by competent people. The boat builder cannot be held responsible for modifications that he has not approved.

In some countries, a driving license or authorization is required, or specific regulations are in force.

Always maintain your boat properly and make allowance for the deterioration that will occur in time and as a result of heavy use or misuse of the boat.

Any boat, no matter how strong it may be, can be severely damaged if not used properly. This is not compatible with safe boating. Always adjust the speed and direction of the boat to sea conditions.

If your boat is fitted with a life raft, carefully read its operating manual. The boat should have onboard the appropriate safety equipment (lifejackets, harness, etc.) according to the type of boat, weather conditions, etc. This equipment is mandatory in some countries. The crew should be familiar with the use of all safety equipment and emergency maneuvering (man overboard recovery, towing, etc.), sailing schools and clubs regularly organize drill sessions.

All persons should wear a suitable buoyancy aid (life jacket/personal floatation device) when on deck. Note that, in some countries, it is a legal requirement to wear a buoyancy aid that complies with their national regulations at all times.

Safety alerts

This manual uses the following safety alerts to draw your attention to special safety instructions that should be followed.

Degree of hazard and corresponding safety labels:

Danger

Denotes that an extreme intrinsic hazard exists which would result in high probability of death or irreparable injury if proper precautions are not taken.

Warning

Denotes that an extreme intrinsic hazard exists which would result in high probability of death or irreparable injury if proper precautions are not taken.

Caution

Denotes that an extreme intrinsic hazard exists which would result in high probability of death or irreparable injury if proper precautions are not taken.

Safe Boating Recommendations

1. Always wear a life jacket

Local authorities require that you carry an approved personal flotation device, or life jacket, for each person aboard your vessel. We recommend wearing a life jacket at all times while boating.

2. Use the kill switch lanyard

The operator of the boat must at all times wear a switch lanyard while driving. In the event of accidental ejection or loss of balance, the boat will shut off automatically. Wearing a switch lanyard would possibly saving the driver's life or that of someone else.

3. Know your boat

Knowing your boat is the foundation of good seamanship, which is simply the skill of managing a boat and encompasses; navigation, safety, boat handling, line handling, anchoring, troubleshooting of engine problems and appropriate emergency response.

4. Take a boating safety course and know the navigation rules

A boating course will teach you the basics of seamanship mentioned above. The knowledge you will gain by taking a boating safety course will never be wasted. Learn to read nautical charts, and keep them on your vessel to become familiar with the area in which you boat. Taking a boating safety course is the next step, where you will learn to navigate using charts, GPS, RADAR and a compass.

5. Boat sober

Alcoholic drinks are even more dangerous on the water than on land because the marine environment accelerates impairment. Besides the safety risks, boating while intoxicated, or BUI, is illegal and heavy penalties are enforced by both state and federal agencies.

6. Avoid collisions.

Observe the rules of priority as defined in the Navigation Rules and imposed by the international regulations for preventing collisions at sea. Ensure that you always have sufficient room to stop or manoeuvre if necessary in order to avoid a collision. Avoid abrupt maneuvers at full speed.

7. Protect people

Always slow down and exercise extreme caution any time you are boating in area where there are people in the water.

8. Respect for environment

Please be aware of local environment laws and international regulations against marine pollution and respect them as much as possible.

9. Control Speed

Do not drive at top speed in areas of heavy boat traffic or in situations of reduced visibility, strong winds or heavy seas. Reduce the boat's speed in big waves and wake out of courtesy and for your own safety and the safety of others. Observe speed limits and "NO WASH" signs.

10. Others:

Do not sit in the bow cockpit when the boat is moving at high speed.

Danger

When operating, passengers must avoid standing up or hanging appendage outside of the boat. Leaking fuel is a fire hazard, inspect fuel system regularly. Shut off the engine before boarding from the water.

Warning

Should the operator or passenger fall out of the boat, the possibility of serious injury or death from being run over by the boat can be greatly reduced by stopping the engine immediately. Always properly connect both ends of the stop switch lanyard to the stop switch and the operator.

Caution

Passengers must use suitable PFDs. Special PFDs are designed for children or watersport activities. (Personal Flotation Device)

Pre-operation check list

- a). Make sure every passenger is wearing a suitable personal flotation device.
- b). Make sure there is an extra buoyant device that can be thrown to rescue person in the water.
- c.) If boating with passengers, instruct at least one passenger in the basics of boat handling, starting and operation of the outboard motor.
- d). Check that every passenger is securely seated and hold a safe line, grab handle or rope.
- e). Make sure that there is a 4m towing rope in the boat.
- f). Make sure the load in the boat is distributed evenly.
- g). Make sure you respect the maximum load specified for the boat as described on the manufacturer's plate.
- h). Make sure that all safety gear is on board, e.g. whistle, floating ropes, waterproof flashlight, first aid kit, fresh water, tool kit...
- i). Check that the boat is equipped with 2 paddlers or oars.
- j). Make sure the outboard motor is securely fastened to the transom.
- k). Make sure the drain plug is fully functional.
- l). Check the pressure level in each chamber using a pressure gauge. Recommended working pressure is displayed on manufacturer's plate.
- m). Check fuel tank level and make sure it suits your plan.
- n). Start the outboard motor and make sure it stops when the lanyard is disconnected from the switch.

Specifications: Ocean Master

Description	OM Models							
	350		390		420		460	
Hull Construction Material	5 series marine grade aluminum alloy							
Deck Construction Material	5 series marine grade aluminum alloy							
Tube Material	PVC or Hypalon coated fabrics							
Overall Length	a	3.5m	3.9m	4.2m	4.6m			
Inside Length	c	2.62m	3.0m	3.26m	3.65m			
Beam	b	1.85m	1.85m	2.1m	2.1m			
Inside Width	d	0.94m	0.94m	1.08m	1.08m			
Bow Height	e	942mm	953mm	1012mm	1013mm			
Stern Height	f	612mm	612mm	666mm	667mm			
Dead Rise	20°		20°		20°		20°	
Airtight Chambers	3		3		4		5	
Light displacement without engine	115Kg	254lb	150.6 Kg	332lb	263.6 Kg	581lb	297.6Kg	656lb
Max Passenger	6		7		8		9	
Max Load	603Kg	1329lb	678Kg	1495lb	771Kg	1700lb	901Kg	1986lb
Main Propulsion	Motor							
Max Engine Power	40HP	29.4KW	50HP	36.75KW	60HP	44.10KW	80HP	58.80KW
Engine Shaft	L		L		L		L	
Design Category	C		C		C		C	
Tube Diameter	470mm		470mm		470mm		470mm	
Max Engine Weight	100Kg		100Kg		110Kg		165Kg	
Fuel Tank Capacity	30L		30L		40L		40L	

General Arrangement

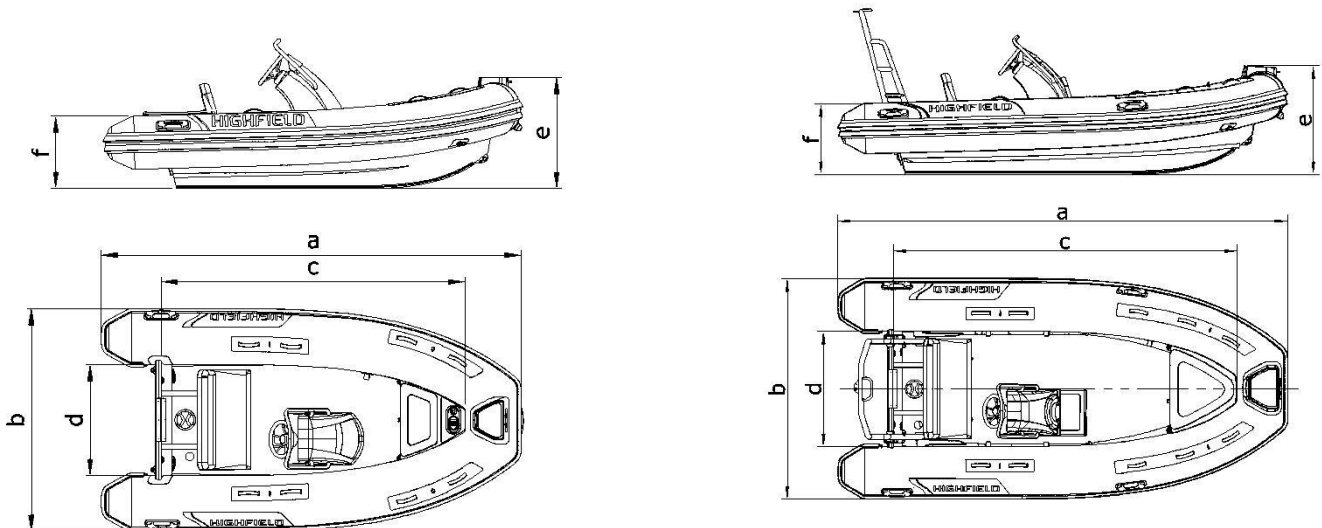

Specifications: Ocean Master

Description	OM Models						
	500		540		590		
Hull Construction Material	5 series marine grade aluminum alloy						
Deck Construction Material	5 series marine grade aluminum alloy						
Tube Material	PVC or Hypalon coated fabrics						
Overall Length	a	5.0m	5.4m	5.9m			
Inside Length	c	4.155m	4.36m	4.83m			
Beam	b	2.28m	2.38m	2.44m			
Inside Width	d	1.2m	1.3m	1.3m			
Bow Height	e	1141mm	1130mm	1170mm			
Stern Height	f	744mm	780mm	780mm			
Dead Rise		24°	24°	24°			
Airtight Chambers		6	6	6			
Light displacement without engine		419.7Kg	925lb	474.6Kg	1046lb	568.6Kg	1254lb
Max Passenger		10		12		14	
Max Load		1008Kg	2204lbs	1223Kg	2696lbs	1498Kg	3303lbs
Main Propulsion		Motor					
Max Engine Power		100HP	74.6KW	115HP	85.76KW	150HP	111.85KW
Engine Shaft		L		XL		XL	
Design Category		C		C		C	
Tube Diameter		520mm		520mm		550mm	
Max Engine Weight		165Kg		220Kg		220Kg	
Fuel Tank Capacity		90L		105L		120L	

General Arrangement

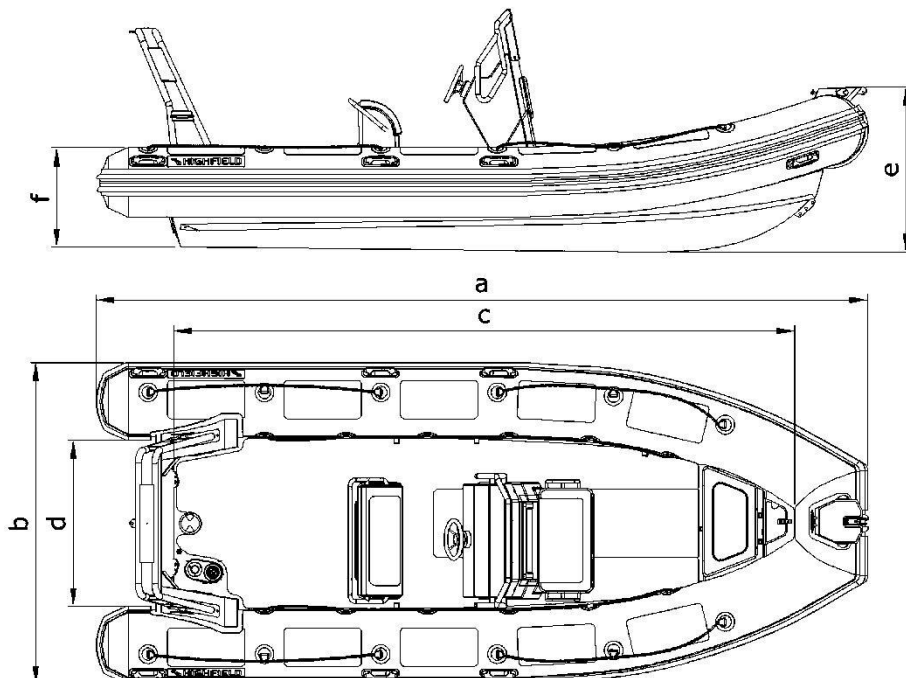

Specifications: Deluxe



Description	DL Models							
	350		390		420		460	
Hull Construction Material	5 series marine grade aluminum alloy							
Deck Construction Material	5 series marine grade aluminum alloy							
Tube Material	PVC or Hypalon coated fabrics							
Overall Length	a	3.5m	3.9m	4.2m	4.6m			
Inside Length	c	2.15m	2.55m	2.6m	3.0m			
Beam	b	1.89m	1.89m	2.1m	2.1m			
Inside Width	d	0.92m	0.92m	1.08m	1.08m			
Bow Height	e	961mm	961mm	1024mm	1034mm			
Stern Height	f	595mm	595mm	666mm	666mm			
Dead Rise	20°		20°		20°		20°	
Airtight Chambers	3		3		4		5	
Light displacement without engine	180Kg	397lb	210.6Kg	464lb	263.6Kg	581lb	295.6Kg	652lb
Max Passenger	6		7		8		9	
Max Load	680Kg	1499lb	780Kg	1720lb	850Kg	1874lb	900Kg	1984lb
Main Propulsion	Motor							
Max Engine Power	40HP	29.4KW	50HP	36.75KW	60HP	44.10KW	80HP	58.80KW
Engine Shaft	L		L		L		L	
Design Category	C		C		C		C	
Tube Diameter	470mm		470mm		470mm		470mm	
Max Engine Weight	100Kg		100Kg		110Kg		165Kg	
Fuel Tank Capacity	30L		30L		40L		40L	

General Arrangement

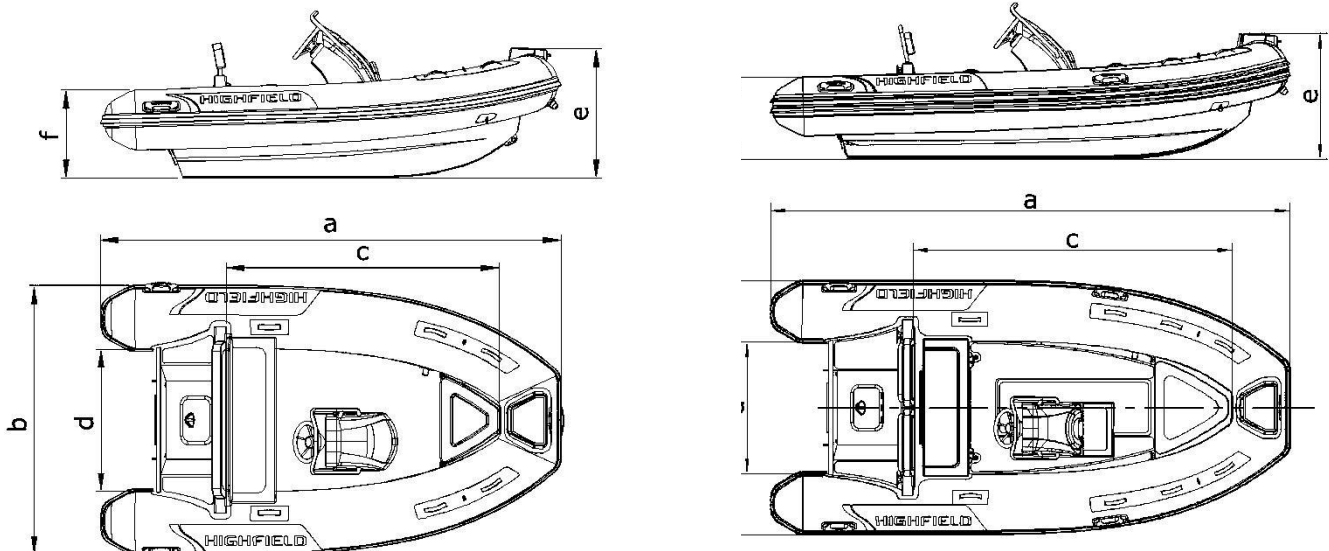

Specifications: Deluxe



Description		DL Models							
		500		540		590		640	
Hull Construction Material		5 series marine grade aluminum alloy							
Deck Construction Material		5 series marine grade aluminum alloy							
Tube Material		PVC or Hypalon coated fabrics							
Overall Length	a	5.0m		5.4m		5.9m		6.4m	
Inside Length	c	3.4m		3.7m		4.25m		4.6m	
Beam	b	2.3m		2.38m		2.44m		2.45m	
Inside Width	d	1.2m		1.3m		1.3m		1.3m	
Bow Height	e	1141mm		1130mm		1170mm		1307mm	
Stern Height	f	744mm		780mm		780mm		833mm	
Dead Rise		24°		24°		24°		24°	
Airtight Chambers		6		6		6		6	
Light displacement without engine		483.06 Kg	1065lb	519.6 Kg	1146lb	579.6 Kg	1278lb	651.6 Kg	1437lb
Max Passenger		10		12		14		16	
Max Load		1000Kg	2205lb	1200Kg	2645lb	1400Kg	3086lb	1724Kg	3801lb
Main Propulsion		Motor							
Max Engine Power		90HP	73.5 KW	115HP	84.53 KW	145HP	102.9 KW	175HP	128.63 KW
Engine Shaft		L		XL		XL		XL	
Design Category		C		C		C		C	
Tube Diameter		520mm		520mm		550mm		550mm	
Max Engine Weight		180Kg		220Kg		280Kg		270Kg	
Fuel Tank Capacity		90L		105L		120L		140L	

General Arrangement

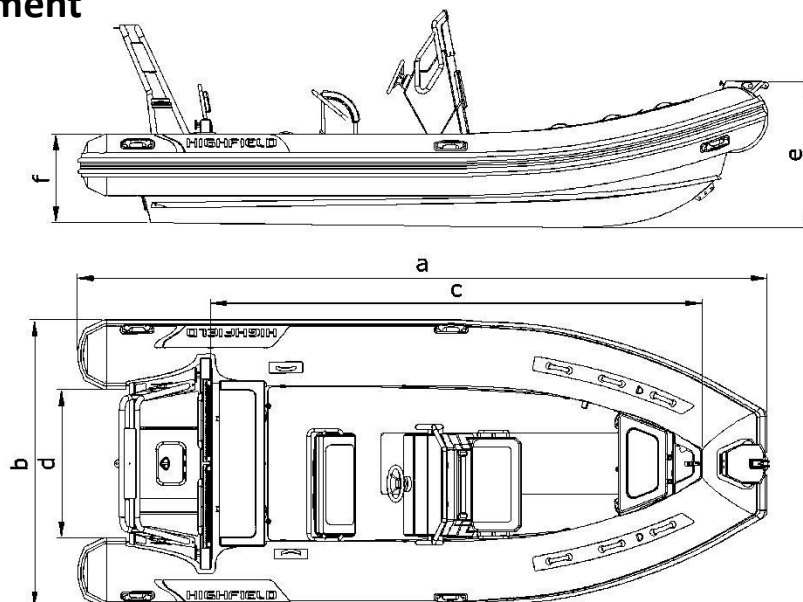

Notes:

- a) Overall Length: Including removable parts that can be dismantled, without affecting the structure of the boat.
- b) Inside Length: Excluding removable parts that can be dismantled, without affecting the structure of the boat.
- c) Beam: Including removable parts that can be dismantled, without affecting the structure of the boat.
- d) Inside width: Excluding removable parts that can be dismantled, without affecting the structure of the boat.
- e) Fuel Tank Capacity: It may not be possible to use this capacity fully depending on the trim and load of the boat. It is recommended to keep a reserve of 20% in the fuel tanks.
- f) Category C: Craft designed to operate in winds up to Beaufort force 6 and the associated wave heights (significant wave height up to 2m). Such conditions may be encountered in exposed inland waters, in estuaries, and in coastal waters in moderate weather conditions.(ISO10240)
- g) Load distribution
 - Please refer to the maximum numbers of passengers and load capacity of the boat in this manual or on the builder's plate. Do not exceed the maximum number.
 - Position the passengers and distribute the load evenly in the boat to help counterbalance the weight of the outboard.
 - In rough waters, load can be moved forward to ease the motion of the craft.
- h) If some of those onboard are children, the total number of people allowed onboard may be increased, provided that:
 - The total weight of the children does not exceed 37.5Kg; and that
 - The total weight of all allowed onboard (based on about 75Kg per adult) is not exceeded.

Warning

Do not exceed the maximum recommended number of persons. Regardless of the number of persons on board, the total weight of persons and equipment must never exceed the maximum recommended load. Always use the seats/ seating spaces provided.

When loading the boat, never exceed the recommended maximum load. Always load the boat carefully and distribute loads appropriately to maintain design trim (approximately level). Avoid placing heavy weights high up.

Do not install an engine in this boat with a higher rated power than that indicated on the Builder's plate as below.

Do not operate the boat with an engine of rated power greater than the maximum recommended power. Overpowering a boat can result in serious injury, death or boat damage.

Use negative trim to go from cruising speed to planning speed and at low speeds (applicable to boats equipped with a system for directing the propeller thrust).

Do no drive the boat at high speed with a negative trim of the propulsion equipment (bow down).

Recommended Seating Arrangement (Ocean Master)

NOTE: ● Occupant Position

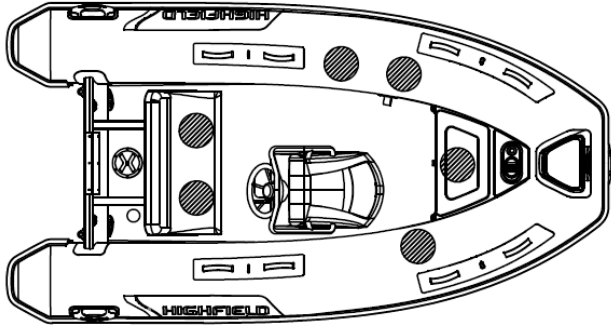

OM350

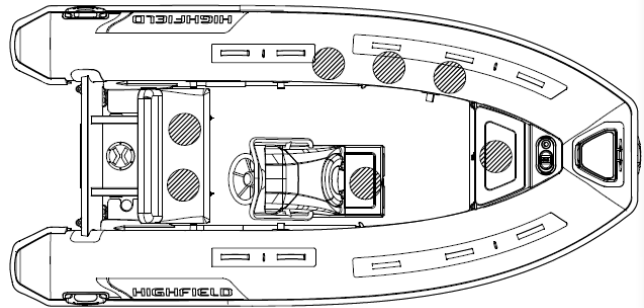

OM390

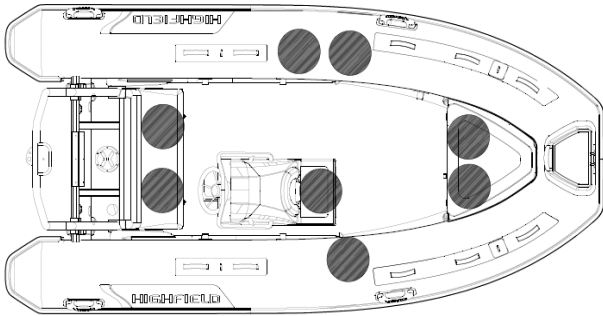

OM420

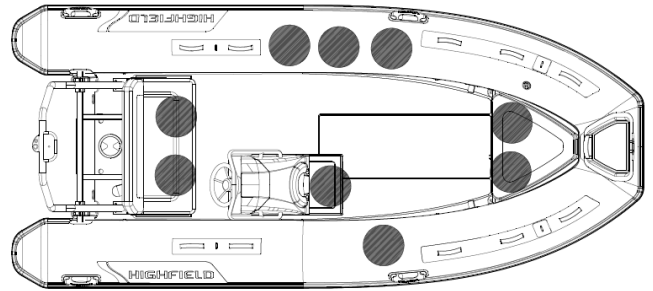

OM460

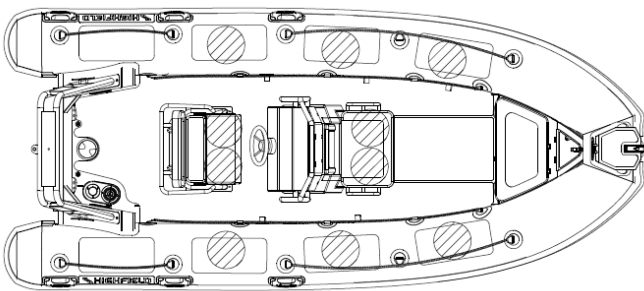

OM500

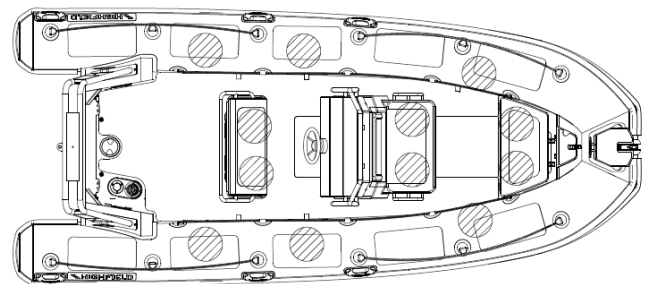

OM540

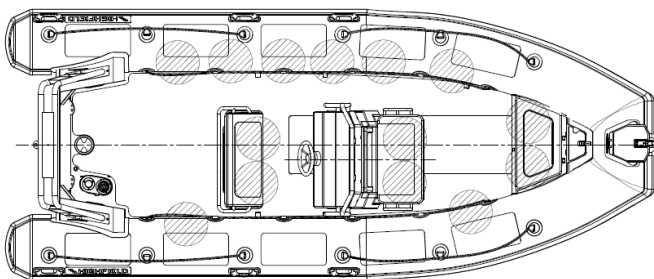

OM590

Recommended Seating Arrangement (Deluxe)

NOTE: ● Occupant Position

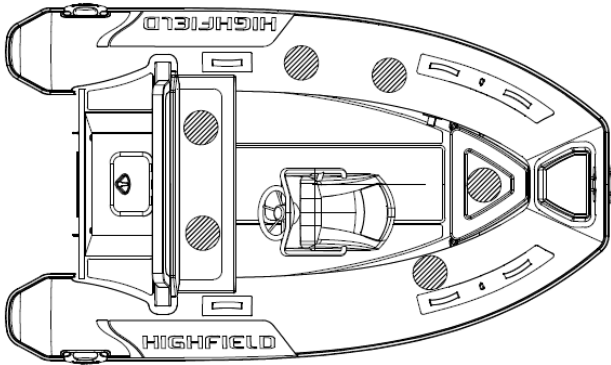

DL350

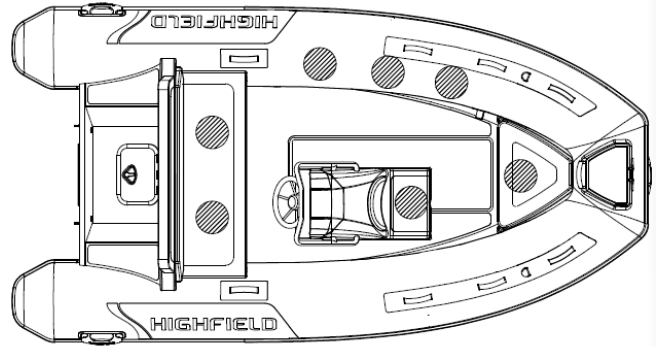

DL390

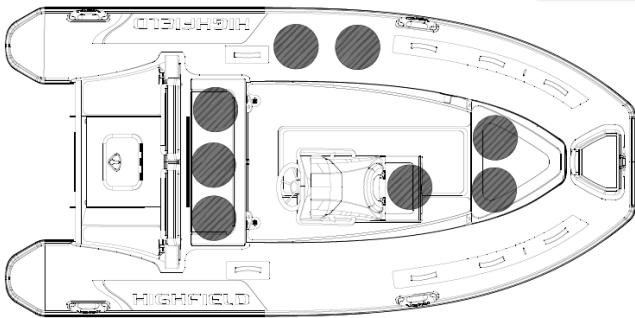

DL420

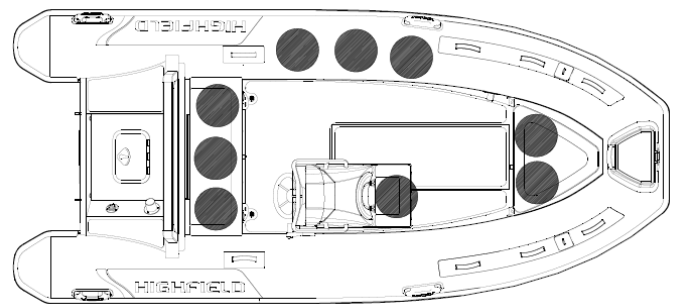

DL460

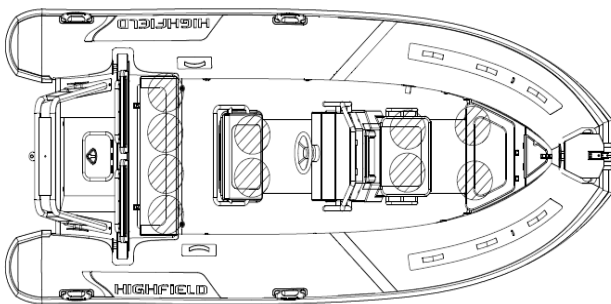

DL500

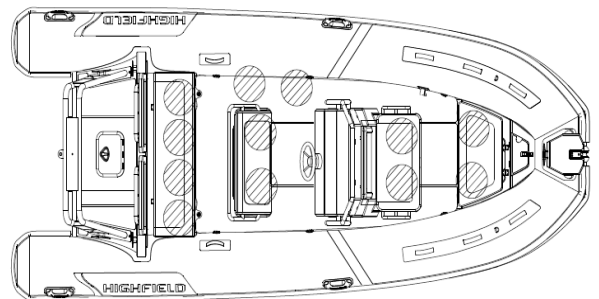

DL540

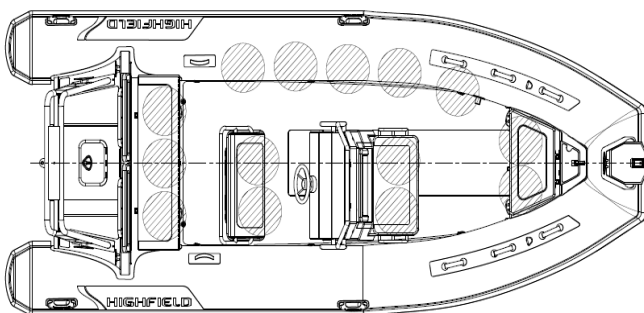



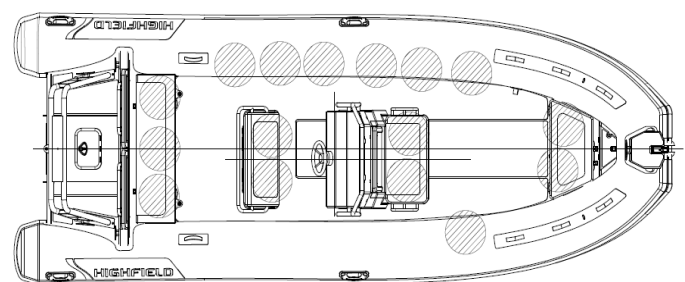







DL590



DL640

Builder' Plate:

Part of the information is given on the builder's plate affixed on the inside of the boat transom. A full explanation of this information is given in the relevant sections of this manual.

 HIGHFIELD aluminium boats	
Model <u> </u> b	Cat. <u> </u> c
 = <u> </u> d kW <u> </u> HP	
 = <u> </u> e  = <u> </u>	
 +  +  +  = <u> </u> f kg <u> </u> lbs	
 = <u> </u> g bar <u> </u> psi	
 <p>Alteration of the boat's hull or permanent fittings may invalidate the particulars on this plate. The recommended persons and maximum load should be reduced in bad weather or when the boat is operated offshore. Refer to the owner's operation manual before operation.</p>	
BUILT TO ISO 6185  www.highfieldboats.com	

Notes:

a: Name of manufacturer

b: Model

c: Design category

d: Maximum motor power

e: Maximum number of passengers

f: Maximum load capacity

g: Recommended working pressure

Fuel System

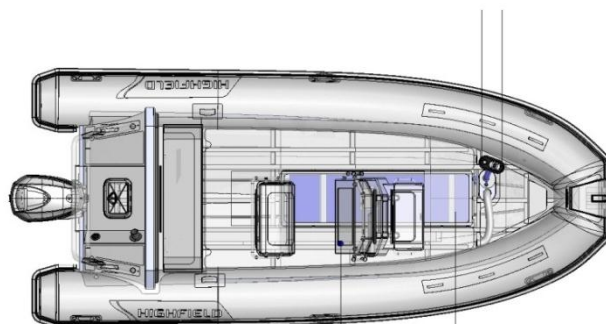
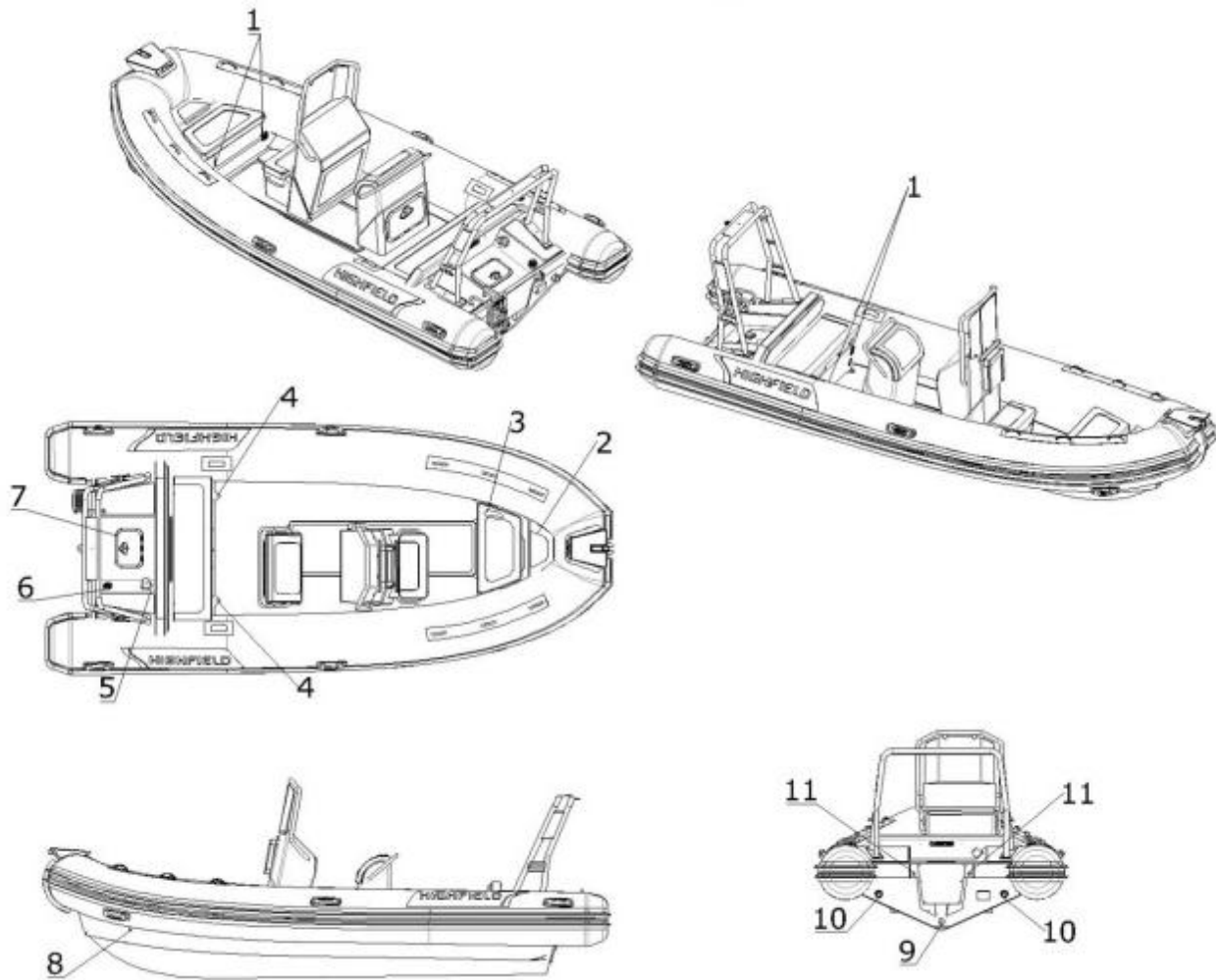

Chart of Fuel System

Reference	Designation
1	Anti-flooding valve
2	Fuel filler and tank vent hole
3	Fuel gauge indicator
4	Petrol fuel tank

Information connected with the risk of flooding and stability

1. Openings in the hull



Reference	Designation
1	Ventilation grids
2	Anchor locker
3	Fuel filler
4/10	Drain scupper-cockpit/ deck
5	Engine rigging flange
6/11	Motor well boot
7	Inspection hatch
8	Fuel filler drain
9	Bilge drain plug

Use of drain plug

Reference	Designation	Location	Direction for use			Picture
			In water at rest	In water in motion	Out of water	
1	Scupper	Transom	N/A	N/A	N/A	
2	Bilge drain plug	Transom	Closed	Closed	Open	
3	Cockpit plug	Rear seat vertical panel	Closed	Open	Open	

Caution

Keep the bilge drain plug open when the boat is kept outside of the water. The rain water could fill the boat and create stress and damage.

Danger

Do not open the bilge drain plug when the boat is afloat.

Do not try to access the bilge drain plug when motor is running. Propeller may cause serious injury.

2. Stability and buoyancy

This boat has been assessed as capable of supported the weight of the crew, even in the event of flooding.

- Fully laden displacement was used to evaluate the stability and buoyancy of the boat. The value of this displacement can be found in paragraph "Specifications" as below.
- Any changes in the distribution of loads onboard (for example by adding a raised structure for fishing, fitting radar or in-mast furling, changing the engine etc.) can significantly affect the boat's stability, trim and its performance.
- It is important to keep water in the bilges to a minimum.

-
- d) The boat's stability is affected by adding to the weight of the superstructure.
 - e) When under way, it is advisable to shut the hatches, lockers and doors to minimize the risk of flooding.
 - f) The boat's stability can be reduced when towing a boat or when using a davit or boom to lift a heavy load.
 - g) Air chambers shall not be punctured.
 - h) Breaking waves are a serious stability hazard.

Warning
<i>Always adjust the speed and heading of your boat according to the sea conditions.</i>
<i>All of the watertight hatches and bilge drain plug must remain closed when at sea.</i>

Information connected with the risk of fire or explosion

1. Propulsion engine

- a) Make sure that the cooling water is circulating properly thru the engine.
- b) Ensure that ventilation openings in the compartment fuel tank are not obstructed.
- c) Stop the engine and refrain from smoking during fuel tank filling.
- d) Get your fuel circuit checked regularly by a professional engineer.
- e) Avoid any contact between inflammable materials and the hot sections of the engine.
- f) Never switch off or de-energize the electric system when the engine is running.
- g) Never block the access of the fuel supply valve.
- h) Do not obstruct or modify the ventilation system. Ensure that ventilation ducts are free.
- i) Never turn the engine over when the boat is on land.
- j) Fuel stored outside the fuel tanks (jerry cans, spare cans) must be kept in a well-ventilated place.
- k) Regularly check that the petrol tank compartment is clean and dry.
- l) Take all necessary precautions to avoid contact with naked flames and other hot areas.

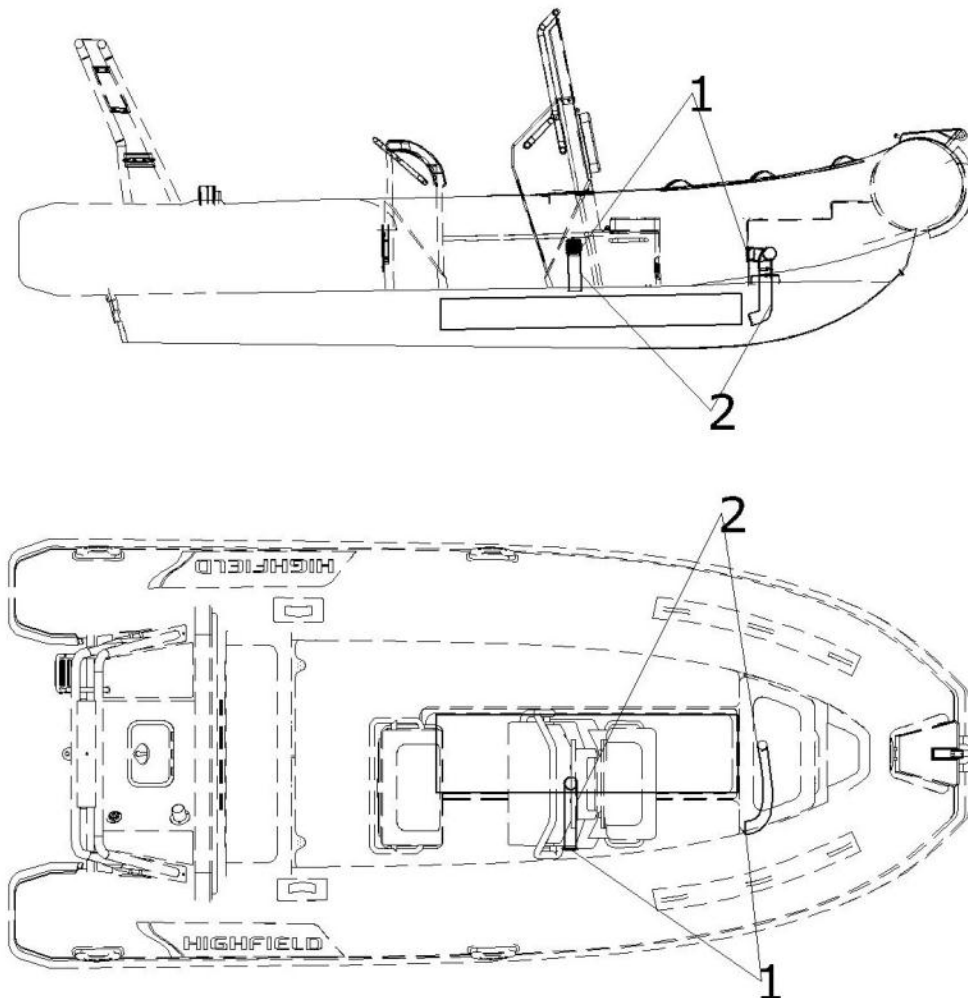

Diagram of the layout- Ventilation of petrol tank compartment

Warning

Portable fuel tank should be filled outside of the boat.

Always fill tanks in a ventilated area, motor should be turned off.

Do not smoke when filling the tanks.

2. Fire prevention and fire-fighting equipment

(1) Portable fire-extinguishers and fire blanket (not supplied)

- a) When in use, this boat must be equipped with portable fire extinguishers of the following extinguishing capacity and located in the following places.
- b) The location of the portable fire extinguishers is shown by the pictogram below:

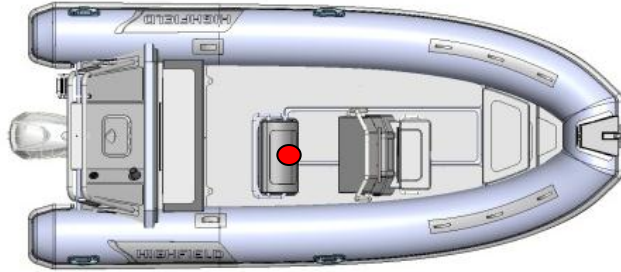

Location for portable extinguisher

Reference	Designation	Location	Minimum extinguishing capacity
1	Portable extinguisher	● seat	8A/6B

Warning

Boats equipped with a 25kW or larger outboard engine must have onboard one or more portable fire extinguishers with a total combined capacity of at least 8B/6B

The fuel tank compartment has a port that makes it possible to inject the extinguishing product inside. The fire port has been designed so that the nozzle of the portable fire extinguisher can be inserted into it and extinguishing product discharged into the fuel tank compartment.



Fire port- located on the port side of the console

(2) Servicing of fire-fighting equipment

The boat owner/operator shall:

- a) Have fire-fighting equipment checked at the intervals indicated on the equipment.
- b) Replace portable fire extinguishers, if expired or discharged, by devices of identical fire-fighting capacity.
- c) Have fixed systems refilled or replaced when expired or discharged.

(3) Responsibility of boat owner/operator

- a) To ensure that fire-fighting equipment is readily accessible when the boat is occupied.
- b) To ensure that any drainage points in the petrol tank compartment are readily accessible.
- c) To inform members of the crew about: the location and operation of fire-fighting equipment, the location of discharge opening into the engine space and the location of routes and exits.

Caution

Keep the bilges clean and check for fuel and gas vapors or fuel leaks frequently. When replacing parts of the fire-fighting installation, only matching components shall be used, bearing the same designation or having equivalent technical and fire-resistant capabilities.

Electrical Systems

Danger

The risks of fire or explosion may result from improper use of electric DC and AC systems.

The risks of electric-shock hazards may result from improper use of electric AC system.

Warning

Do not work on a live electrical system.

Do not modify the electrical system of the boat or the relevant diagrams: It is important that the installation, maintenance and any modifications be carried out by a technician qualified in marine electricity.

Do not change or modify the strength of the safety devices protecting against power surges.

Do not install or replace electrical equipment or materials with components which exceed the system's nominal electrical power capacity.

Do not leave the boat unsupervised when the electrical system is live, apart from when the automatic bilge pump and the boat's fire protection and security systems are in use.

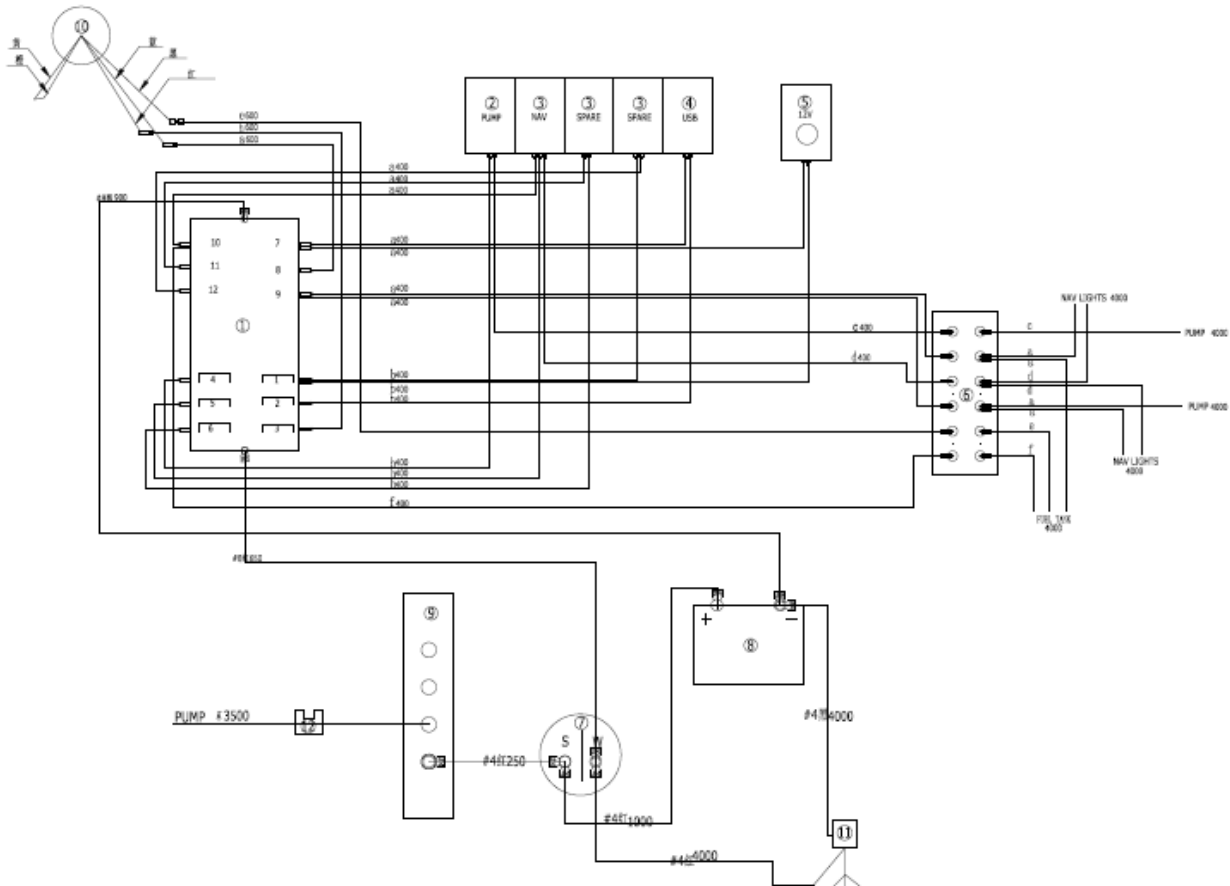

Item	Description	Quantity	Item	Description	Quantity
①	Circuit-breaker 5025B	1	⑦	Power switch	1
②	Semi-auto switch	1	⑧	Battery	1
③	Manual switch	3	⑨	Collector 2303B	1
④	USB 1039B	1	⑩	Fuel Gauge	1
⑤	Socket 1011B	1	⑪	Engine	1
⑥	Terminal 2406B	1	⑫	Circuit-breaker 5064B	1

Transporting

1. For optimum handling, the trailer must be properly loaded and balanced.
2. Keep the center of gravity low for best handling.
3. Approximately 60 percent of the boat's weight should be positioned on the front half of the trailer and 40 percent in the rear.
4. The boat should also be balance from side to side. If the vessel has side mounted fuel or water tanks and only one side is filled, then this will lend the rig to maneuver poorly. Proper balancing will also prolong the life of your trailers tires.
5. The boat should be firmly secured with at least two ratchet type straps, one attached from the trailer to the stern eyes and one strap from the trailer, to the bow eye to keep the boat from shifting forward. The bow eye should also be attached to the trailer's winch which is mounted forward of the bow. Make sure you have sufficient clearance to avoid to damage outboard or boat during transportation.
6. Classic models can be accommodated/ transported on a roof rack. We recommend the boat to be protected from the roof rack that could damage the tube material. Boat should be stowed upside-down. Oars, bench seat and equipments should be removed from the boat. Boat must be secured using reliable nylon tie-down straps with cam-buckles. We recommend also tying a small rope off at the bow towing eye for extra safety.

Engine Start

Before starting the engine, it is imperative:

- a) To open the fuel supply valve
- b) To switch on the battery supply by using the battery isolator switches
- c) To put the control lever in neutral
- d) To attach the circuit-breaker/ kill switch lanyard to the pilot.

Make sure a habit of looking to see if sea water is pumped out with the exhaust gases as soon as you start the engine. If no water runs out, stop the engine immediately. Check the coolant flow.

Danger
<i>Before using the engine, make sure you carefully read the handbook provided by the engine manufacturer.</i>
<i>Always start the engine with the control lever in neutral.</i>
<i>Learn how to judge the necessary distance of deceleration for the vessel to come to a complete stop (The reverse gear is not a brake)</i>
<i>Use the kill switch lanyard.</i>

Operation

1. Inflation

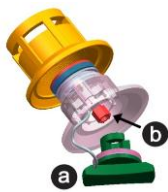

- a- Valve cap
- b- Plunger

- a) To inflate the chamber, first unscrew the valve cap by turning a quarter of a turn counterclockwise. Check that the plunger in the center of the valve is closed i.e. upper position. If closed i.e. spring compressed, down position, push the plunger down and rotate to the closed position.
- b) Connect the air pump to the valve, rotate the connector into the valve to lock it and start inflating. No matter you used foot pump or electrical, please do not inflate over the maximum air pressure 0.25 Bar per chamber.
- c) Use air gauge to measure the tube pressure.



- d) Be sure to inflate each chamber in turn according to the sequence shown below. Do not inflate a chamber completely then move on to the next one. Start with the rear chambers. Repeat procedure until all chambers are evenly inflated to the recommended working pressure.

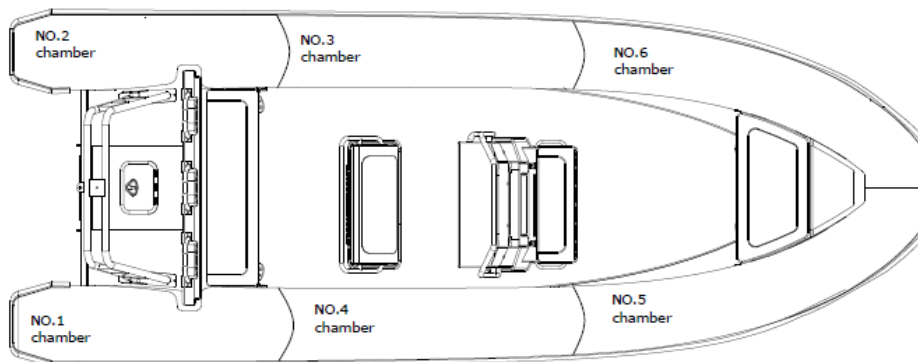

- e) When inflating, please keep the air pressure balance between air chambers to avoid the damage of bulkheads.
- f) Inflatable boats can be damaged by extreme internal air pressure. Such pressure can be caused by temperature differences. A boat properly inflated in the morning may become dangerously over-pressurized as the day warms up. The internal pressure can multiply many times as the surfaces temperature increases and under such conditions, seams can separate and bonded materials can delaminate. Avoid subjecting your inflatable to such conditions by relieving pressure in all chambers of your boat as the day heats up or before leaving the boat exposed to hot midday sun. It is highly recommended that the boat be stored in the shade or under cover when it is not being used.
- g) Using the boat with under inflated tubes may cause serious damage, including transom cracking.

Caution

Do not use a compressed air source to inflate the tube or you may compromise the integrity of the seam or internal baffles. Seams or baffle rupture due to non-respect of inflation procedure is not covered under the warranty.

2. Performance

- (1) To achieve best performance, the boat must plane. If the boat does not plane you may check the following:
 - a) Make sure the bilge/ deck is dry, drain the water otherwise.
 - b) Make sure the tube is correctly inflated.
 - c) Make sure you have the correct weight distribution. Sea conditions may require passengers to move forward to the boat to get the boat on plane before they return to their initial positions.
 - d) Make sure you use a suitable outboard engine for the boat.
- (2) The outboard engine plays a big role in the performance of the boat. Please make sure you use a suitable outboard engine for the boat.
- (3) When you drive your boat, you will have to keep the boat balance fore and aft. To achieve that, you will have to adjust the trim angle of your boat. A properly trimmed hull has two very beneficial results: reduced fuel consumption and increased speed.
- (4) Most outboard engines over 30 horsepower come with a trim and tilt system that is driven by a hydraulic ram located in the center of the engine mounting bracket. Its function is to raise and lower the engine, and it is controlled by an “up/down” rocker switch built into the shift and throttle control that is located directly under your right thumb for ease of access. In the “tilt” mode, the system raises the engine completely out of the water when not in use. It can also be used to raise the engine when running the boat slowly in very shallow water to prevent propeller damage.
In trim mode, the system works to adjust the angle of the engine to affect the running angle of the boat. As the boat increases speed, the engine angle provides the lift necessary to bring the boat on plane for optimal performance. In the full down position, the engine is in “negative trim”, meaning the angle of the engine shaft and propeller is slightly forward of straight down in relation to the transom. This is the position the engine should be in before throttling up from a dead stop. Negative trim exerts downward force on the hull to reduce bow rise that is common to most planning hulls under initial acceleration. The harder the initial acceleration, the greater the tendency the bow will rise. If you throttle up hard from a dead stop, (a procedure called “hole shot”) some hulls will lift the bow at a severe angle momentarily until the downward force of the engine counters the rise.
- (5) Outboard trim angle can be adjusted to improve planning and general performance. Adjust the position of the trim rod of your motor to define the trim angle of the outboard motor in relation to the transom. Make test runs with the trim set to different angles to find the position that works best for your boat and operating condition.

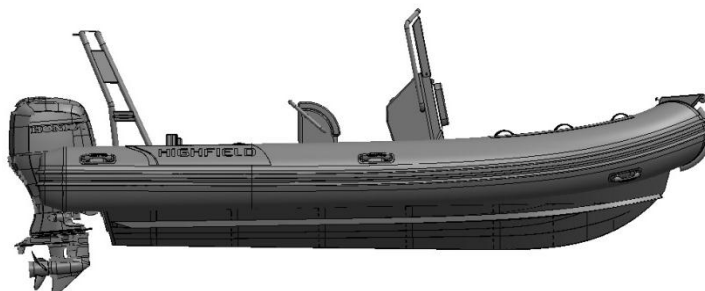

Negative trimmed engine

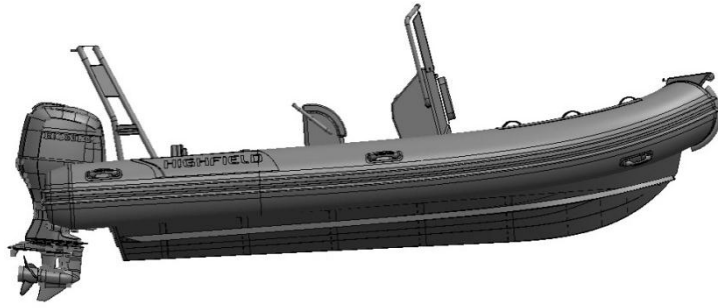

Positive trimmed engine

3. Towing

Your boat can be towed using the towing eye located at the bow. Make sure to use a tow line that is rated at least 5 times the weight of the boat being towed. The boat should only be towed using the towing eye. Molded handles, lifelines and cleats are not designed to be used for towing.

- a) It is recommended that the boat be towed with a bridle arrangement using the D rings on the either side of the bow.
- b) An extra safety line should also be attached to the welded-on aluminum eye under the bow of the hull.
- c) Please note that towed dinghies need to be constantly monitored and especially at night.
- d) When a dinghy is towed, the conditions may vary quite dramatically so the responsibility for its security rests entirely with the skipper.

Warning

The boat must be empty when towed.

Remove outboard motor, fuel tank and equipment before towing.

No passengers should be onboard.

The boat should be towed at low speed.

4. Lifting

When using a hoist to lift the boat, attach the hoist to the 3(or 4 according to your boat's type) lifting eyes welded to the hull. Empty the boat of all equipment and make sure no passenger is onboard during lift. Make sure the deck and bilge are drained before lifting your boat. Remove the drain plug during the whole time the boat is stowed to allow water to run off. Molded handles, lifelines and cleats are not designed to be used for lifting. When lifting and slewing, ensure people are well clear below the slung vessel.

5. Beaching

We recommend the boat not to be powered on to the beach, dragged across rocks, sand, gravel or pavement as damage to the fabric and/or hull result.

6. Outboard motor

Install the outboard motor on the transom so that it is positioned as close to the center as possible. Tighten the transom clamp screws evenly and securely. Occasionally check the clamp screws for tightness during operation of the outboard motor because they could become loose due to engine vibration. Make sure the outboard motor is securely fastened to the transom every time before operation. It is wise to tie the engine to the transom as well as clamping eyes are provided. Always use the kill switch lanyard properly.

The portable tank should be removed from boat when fuelling. The tank should be filled in a ventilated area. Do not smoke onboard.

Warning

Overpowering a boat can result in serious injury, death or boat damage. Do not use outboard that exceeds the maximum horsepower given on the motor plate.

Man-overboard prevention and recovery

1. Man-overboard prevention

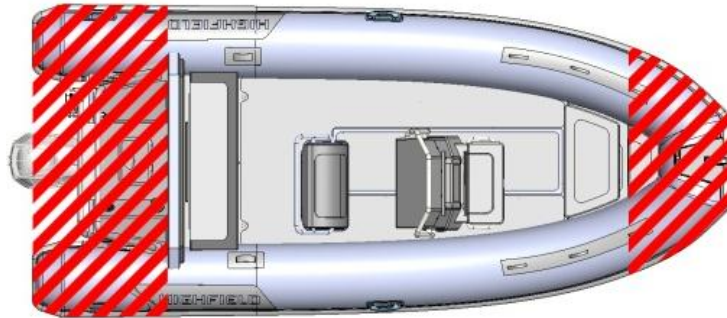

- a) The zones outside the working deck area are the red hatched area as above.
- b) The “working deck” means those areas where people stand or walk during normal use of the boat.
- c) Standing on the bow locker or sundeck is prohibited.

2. Recovery-getting back onboard

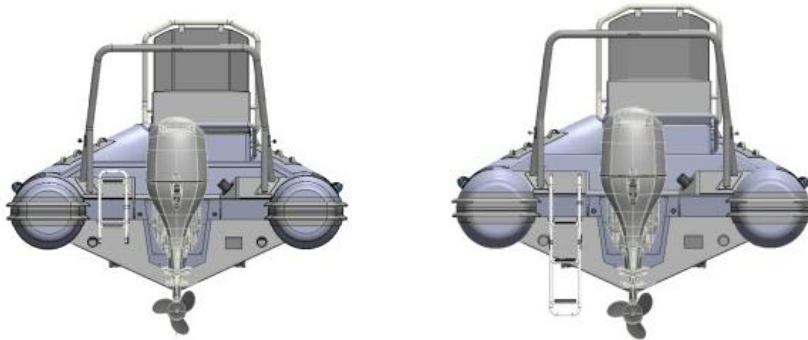

The means for getting back onboard must be able to be deployed by one person alone in the water, with no other help.

Danger

Make sure the means for getting back onboard are readily accessible and easy to use by someone alone in the water

3. Danger from moving parts

Keep the engine off whenever the engine box/cover/hatch is open. The engine box/cover/hatch serves as a machinery guard. Clothing or body parts can get caught in moving parts, causing death or serious injury. Keep away from moving part.



Danger

Contact with a spinning propeller can cause injury and death.

Do not enter or exit the water when the engine is running (ON) and the propeller is spinning.

Do not get on the swim platform when the engine is running.

Do not swim towards the back of the boat if the engine is on.

Maintenance

1. General care

Your inflatable has been especially designed to avoid maintenance problems as far as possible. However, periodic cleaning will help to keep your boat's good condition especially before winter storage. Clean your boat and wash it thoroughly with soapy water. Rinse carefully and check that no dirt or foreign bodies such as shell, sand or fishing hooks are left inside that might deteriorate the fabric. For tar stains use a gentle, nonabrasive cleanser such as dishwashing soap, or use a recommended inflatable boat cleaner available from most boat chandlery outlets.

For upholstery, Highfield is using marine grade fabric to offer best resistance to UV and ageing. Periodic washing with mild detergent and warm water is the best way to keep your upholstery look good. Special vinyl cleaner can also be used to remove difficult stains.

No fabric can last forever when constantly exposed to the sun. To make sure your PVC tubes last, a UV protectant solution must be applied twice a year on the tube fabric. We recommend the use of 303® Aerospace Protectant™.

Caution
<i>Do not use abrasive or aggressive chemical compounds.</i>
<i>Warm soap water is best in most situations.</i>
<i>Do not use any solvents, petrol, etc. (PVC models).</i>
<i>Use solvents sparingly only on Hypalon models.</i>
<i>Test any cleaner on a piece of patch material if in doubt.</i>

2. Deflation

To deflate the chamber, first unscrew the valve cap by turning a quarter of a turn counterclockwise. Check that the plunger in the center of the valve is closed i.e. upper position. If closed i.e. spring compressed, down position, push the plunger down and rotate to the closed position.

Connect the air pump to the valve, rotate the connector into the valve to lock it and start deflating.

Deflate each chamber in turn, do not deflate a chamber completely then move on to the next one. Start with the rear chambers. Repeat procedure until all chambers are completely deflated.

Caution
<i>This is not an exhaustive list of recommendations: Your dealer will give you the advice you need and will carry out the technical maintenance of your boat.</i>

3. Storage

We recommend you to cover your boat when not in use.

- a) When not in use boat should be removed from water.
- b) Before storage the boat should be cleaned and rinsed with fresh water.
- c) Do not cover boat before it is completely dry or mildew could grow under the cover and damage the tube material
- d) The covers should be ventilated and the drain plug left out.
- e) Check the expiry dates of the safety equipment.
- f) Have the boat overhauled.
- g) Grease and close all the valves and through-hull fittings.
- h) Grease all mechanical and moving parts (bolts, hinges, locks...).

- i) Close all the boat's seacocks.
- j) Put the covers back on the electronic screens.
- k) Air all of the cushions and upholstery for a good while before putting them back onboard and arranging them so as to limit the surface areas touching.
- l) Remove the movable upholstery.
- m) Disconnect the batteries. Make sure you recharge them during the winter period if the boat is left inactive for too long.

Caution

The winterization of the engine requires the skills of a professional engineer: please consult your dealer.

This is not an exhaustive list of recommendations: Your dealer will give you the advice you need and will carry out the technical maintenance of your boat.

4. Tube repair

(1) Repair Kit contains:

- a) Fabric patches;
- b) Ready to use tube of special glue

(2) Conditions necessary for a successful repair:

- a) Humidity max 60%.
- b) Temperature range between 18 and 25 degrees Celsius.
- c) Repairs should not be carried out in direct sunlight, wind or rain.
- d) Repairs should, however, be undertaken in a well-ventilated area.

(3) Repair PVC boats:

Highfield Inflatables that have tubes constructed with Valmex PVC coated fabrics require PU based adhesive and RC hardener. Acetone solvent is recommended to prepare the surface before gluing. Use only recommended solvent and adhesive.

- a) Identify the area to be patched. This can be done by running water over the suspect area or spraying or brushing with soapy water.
- b) If the hole is only small, cut out a round patch of no less than 60mm diameter. Large holes or cuts will require proportionately larger patches but always ensure you have at least 30mm of patch around the perimeter of the cut or hole and the corners are well radiused
- c) Next hold the patch on the tube and mark out around it with a pencil.
- d) Clean both surfaces with solvent and spread a thin layer of adhesive over them ensuring there are no lumps.
- e) When the first coat is dry to the touch (about 10 to 15 minutes) apply a second thin coat.
- f) After waiting 5 or 6 minutes, touch the adhesive with the back of your hand. If it no longer appears wet, heat both areas with a hot air gun to re-activate the glue and join the patch to the tube and then clamp or roll the surfaces together. For the best adhesion, roll over the patch with a roller or over the bottom edge of a bottle.

Caution

Do not inflate the boat fully for 24 hours.

(4) Repair Hypalon boats:

Highfield Inflatables that have tubes constructed with Orca Hypalon coated fabrics cannot be bonded with plastic adhesives or by welding. They require neoprene based glue and RFE hardener. MEK solvent is recommended to prepare the surface before gluing. Use only recommended solvent and adhesive.

- a) Identify the area to be patched. This can be done by running water over the suspect area or spraying or

brushing with soapy water.

- b) If the hole is only small, cut out a round patch of no less than 60mm diameter. Larger holes or cuts will require proportionately larger patches but always ensure you have at least 30mm of patch around the perimeter of the cut or hole and the corners are well radiused.
- c) Next hold the patch on the tube and mark out around it with a pencil.
- d) Use a grinder, coarse sand paper or scratch stone, rough up both the back of the patch and the area marked on the tube.
- e) Clean both surfaces with solvent and spread a thin layer of adhesive over them ensuring there are no lumps.
- f) When the first coat is dry to the touch (about 10 to 15 minutes) apply a second thin coat. After waiting 5 or 6 minutes, touch the adhesive with the back of your hand. If it no longer appears wet, heat both areas with a hot air gun to re-activate the glue and join the patch to the tube and then clamp or roll the surfaces together. For the best adhesion, roll over the patch with a roller or over the bottom edge of a bottle.

Danger

Glue and solvent used for repair are highly flammable. Perform repairs in a well-ventilated area. Avoid breathing the vapors, wear protective gears (goggles, filter respirators, latex gloves).

Warranty

The product you have purchased comes with a limited warranty from Highfield Inflatables. The terms of the warranty are set forth in the Warranty Information section of this manual. The warranty statement contains a description of what is covered, what is not covered and the duration of coverage. Please review this important information. The description and specifications contained herein were in effect at the time this manual was approved for printing. Highfield Inflatables, whose policy is one of continued improvement, reserve the right to discontinue models at any time, to change specification, designs, methods, or procedures without notice and without incurring obligation.

Record your Hull Identification Number (HIN).

The HIN is located on the transom plate of your boat. You will need this information to obtain parts, warranty service or provide information if your inflatable boat is stolen.

Highfield Boats—Retail Limited Warranty

1. WHAT IS COVERED

Highfield boats are warranted to be free of defects in material and workmanship during the period described hereafter:

2. DURATION OF COVERAGE

- a) The entire vessel is covered for a period of **two (2) years** from the date the product is sold.
- b) The hull structure is covered by a **five (5) years** warranty.
- c) For commercial use or hire, the entire vessel has a **one (1) year** warranty.

3. POWDER COATING

The powder coating is warranted for a period of 2 years against manufacturing defects.

This warranty excludes damage due to misuse of the boat and chemical or mechanical shocks such as:

- a) Collision, fire, theft, riot, etc.
- b) Alteration, modification, and tampering.
- c) Environmental corrosion and shocks due to acid rain, chemical fallout, industrial pollution, bird lime, tree sap, hail, extreme weather, etc.

4. CONDITION THAT MUST BE MET IN ORDER TO OBTAIN WARRANTY COVERAGE

Warranty coverage is available only to customers that purchase from an authorized Highfield dealer. Routine maintenance outlined in the Owner's manual must be performed in a timely manner in order to maintain warranty coverage. If the retail customer performs this maintenance, Highfield Boats reserves the right to make future warranty coverage contingent on proof of proper maintenance.

5. WHAT HIGHFIELD BOATS WILL DO

Highfield Boats sole exclusive obligation under this warranty is limited to, at our option, repairing a defective part, replacing such part or refunding the purchase price of the Highfield Boats product. The repair, replacement of parts, or the performance of service under this warranty does not extend the life of this warranty beyond its original expiration date.

6. HOW TO OBTAIN WARRANTY COVERAGE

The customer must provide Highfield Boats with a reasonable opportunity to repair, and reasonable access to the product for warranty service. Warranty claims shall be made by delivering the product for inspection to a Highfield Boats dealer authorized to service the product. If the service provided is not covered by this warranty, the purchaser shall pay for all related labor and material, and any other expenses associated with that service. The purchaser shall not, unless requested by Highfield Boats, ship the product or parts of the product directly to Highfield Boats. Proof of registered ownership must be presented to the dealer at the time warranty service is requested in order to obtain coverage.

7. WHAT IS NOT COVERED

- a) This limited warranty does not include damage due to misuse abuse, negligence, improper or inadequate storage or transportation, or to any Highfield boat which is used in a manner contrary to directions or instructions indicated in the Highfield Owner's Manual.
- b) The warranty does not cover routine maintenance items, adjustments, normal wear and tear, puncture, discoloration, oxidation, abrasion, mildew or damages due to theft, loss, modification or alternation.
- c) Wear parts including but not limited to rubbing strake, keel guards, ropes are not covered by the warranty.
- d) This warranty shall be ineffective if the boat has been operated without proper inflation, or with an outboard motor which exceeds the maximum horsepower rating listed on the serial plate attached to the transom.
- e) Powder coating condition is not covered by our warranty due to the specific exposed nature of the product.
- f) For best long term protection, ensure that your surfaces are rinsed with fresh water after every use and are cleaned immediately of any substances that my stick to the paint surface and cause discoloration or damage.
- g) We recommend scratches and dents to be repaired as soon as possible after they occur.
- h) Use of the product for racing or other competitive activity voids the retail warranty.
- i) Expenses related to haul-out, launch, towing, storage, transportation, telephone, rental, inconvenience, slip fees, insurance coverage, loan payments, loss of time, loss of income, or any other type of incidental or consequential damages are not covered by this warranty.

8. TRANSFER OF WARRANTY

The limited warranty is transferable to a subsequent purchaser, but only for the remainder of the unused portion of the limited warranty. This does not apply if the vessel is used for rental or commercial use.

To transfer warranty please send an email with the below information to warranty@highfieldboats.com.

- a) Copy of the sale agreement.
- b) HIN of the boat
- c) Name, address, email address of new owner.

Product Information	
<i>Model</i>	
<i>HIN</i>	
<i>Purchase Date</i>	
Dealer's Information	
<i>Name</i>	
<i>Address</i>	
<i>Phone</i>	
<i>Dealer's Stamp</i>	
Customer's Information	
<i>Name</i>	
<i>Address</i>	
<i>Email Address</i>	
<i>Phone</i>	

Service assistance

For assistance please contact your Highfield dealer and visit Highfield Inflatable website:

www.highfieldboats.com